

S54

AYARLANABİLİR
İÇ MEKAN SİSTEMİ

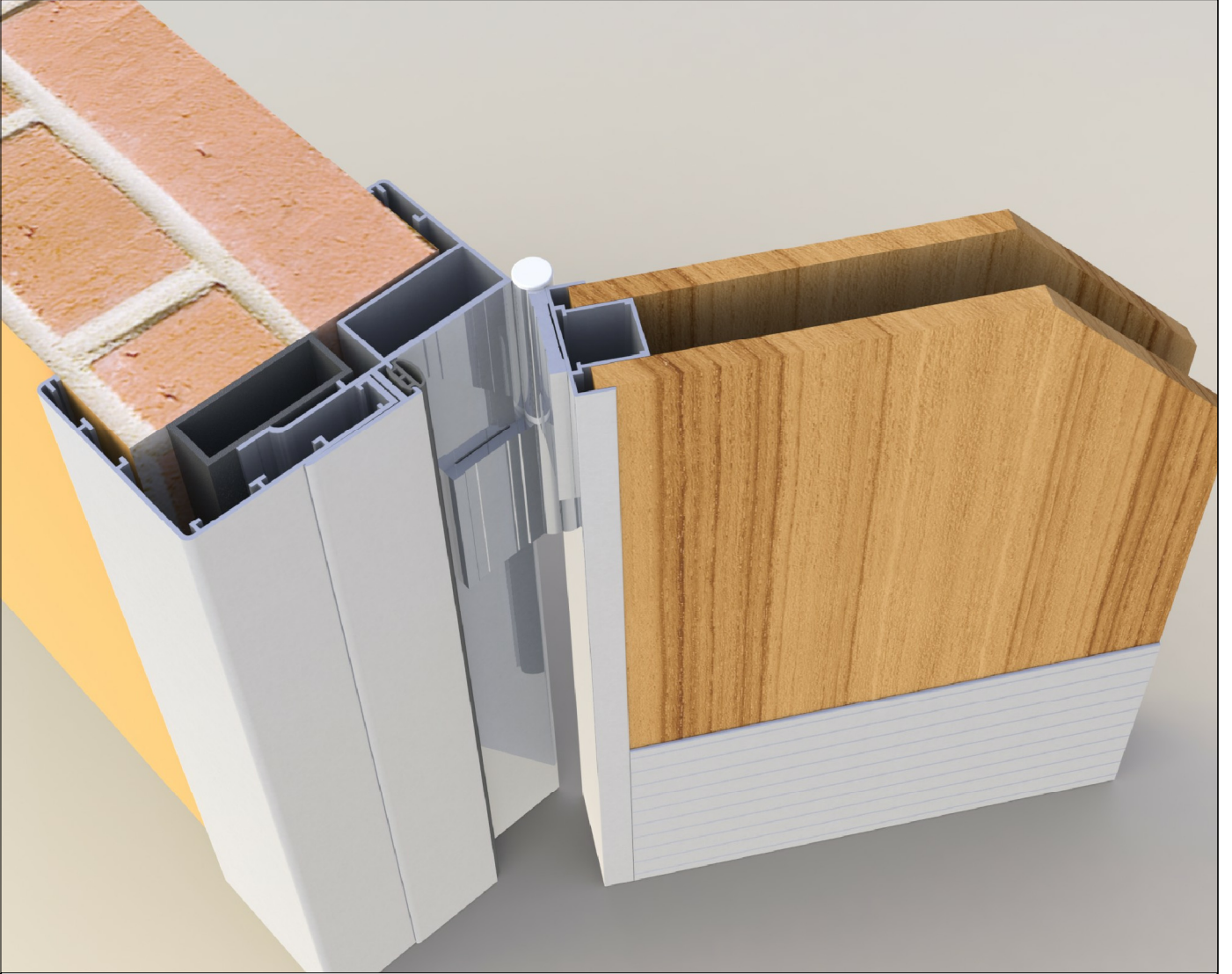

GENCER
alüminyum profil

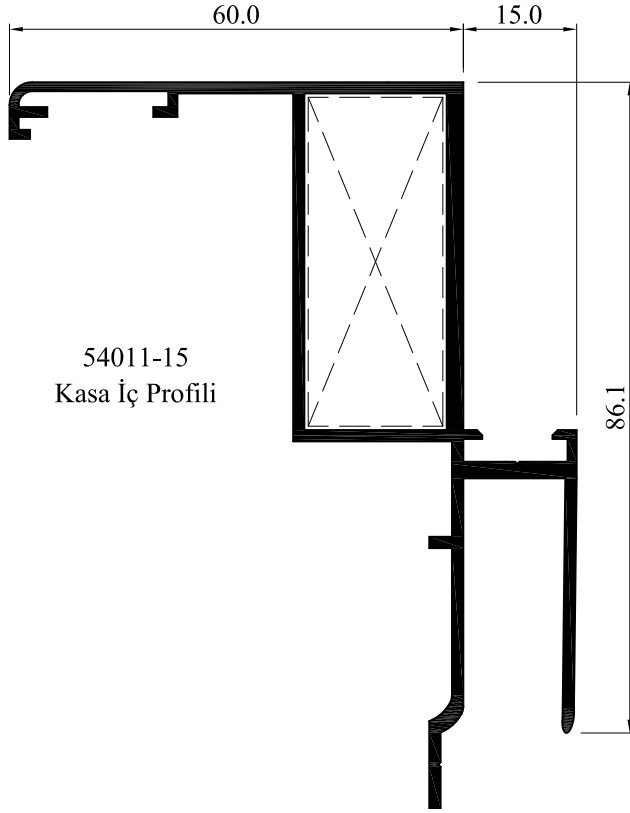

54011-15
Kasa İç Profili

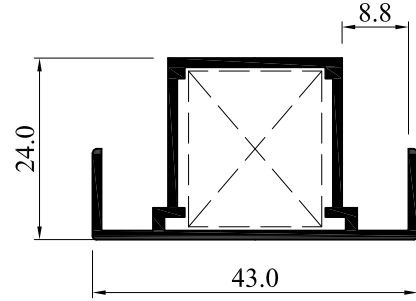

54031-12
Kanat Profili

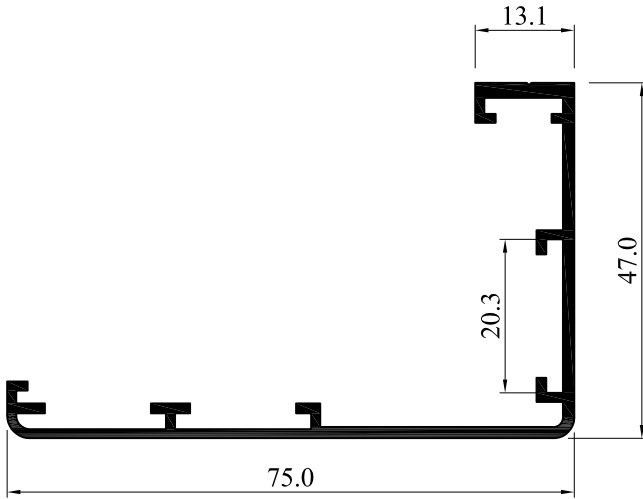

54051-15
Kasa Dış Profili (85-110mm)

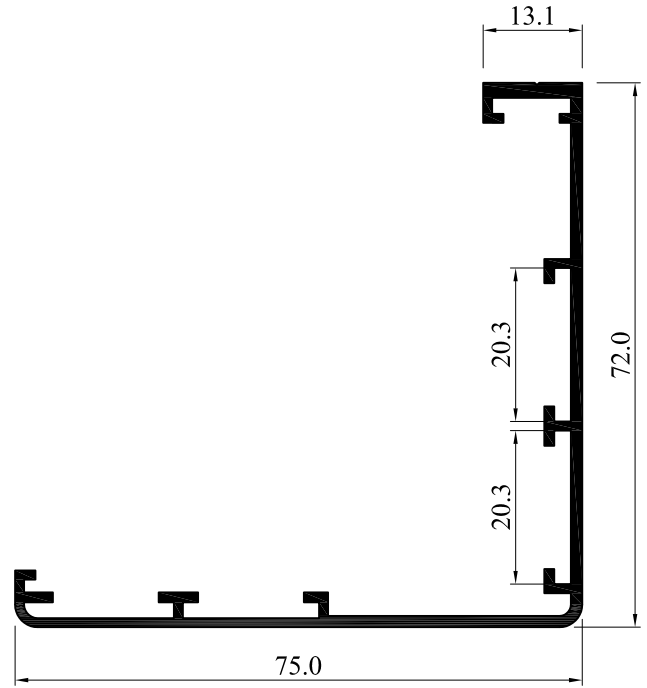

54052-15
Kasa Dış Profili (110-135mm)

PROFİL KODU	AĞIRLIK (kg/m)	PRES TAKOZU/ KESİM ÖLÇÜSÜ (mm)
54011-15	1.290	T851-185 / 44.0
54031-12	0.455	T851-210 / 18.1
54051-15	0.652	
54052-15	0.778	

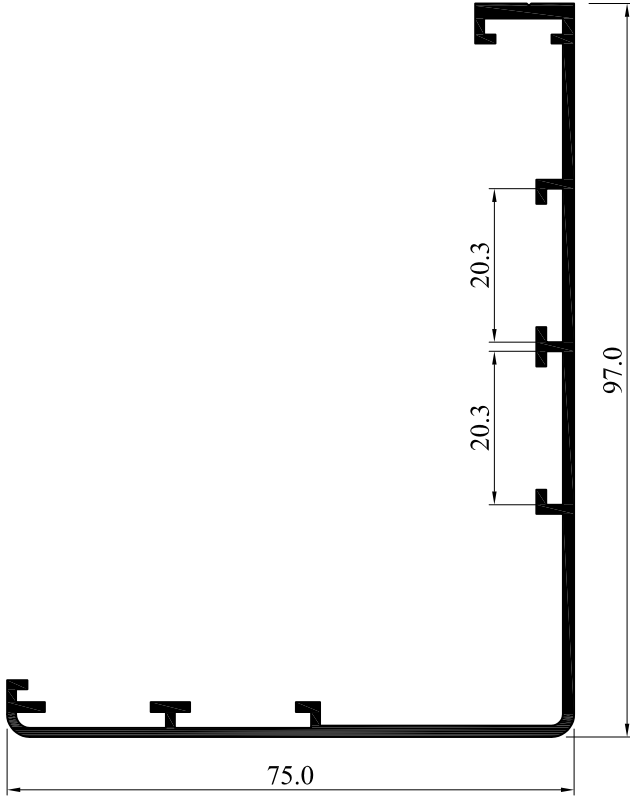

54053-15
Kasa Dış Profili (135-160mm)

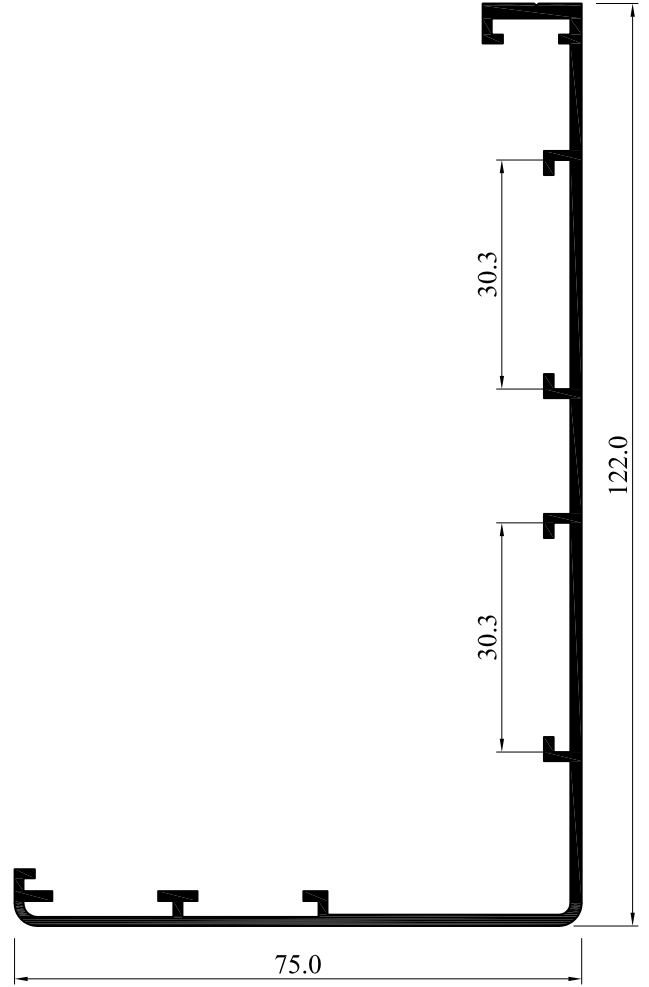

54054-15
Kasa Dış Profili (160-185mm)

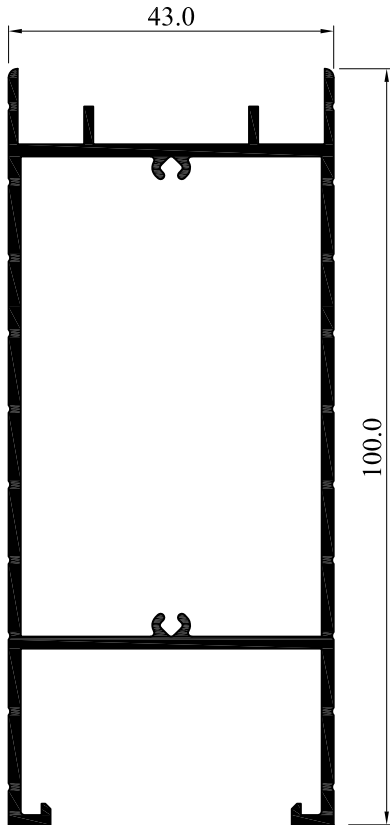

54111-16
Etek Profili



5474
menteşe

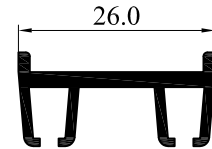

1269-00

PROFİL KODU	AĞIRLIK (kg/m)
54053-15	0.880
54054-15	0.993
54111-16	1.292
1269-00	0.269

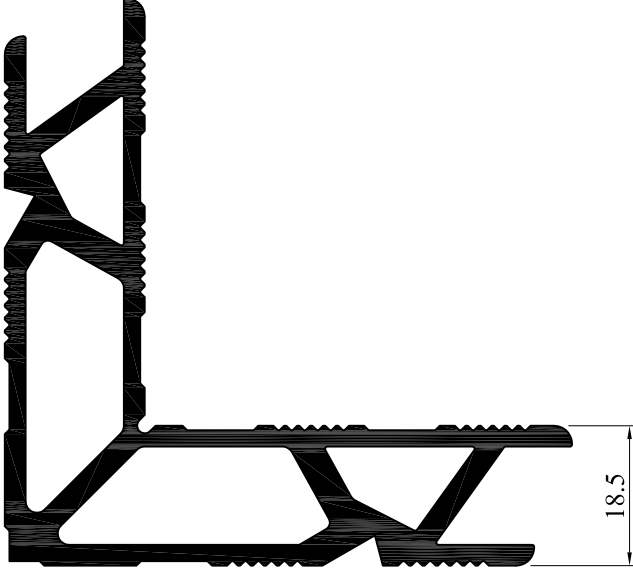

T851-185
Köşe Takoğu (54011-15 de kullanılır)

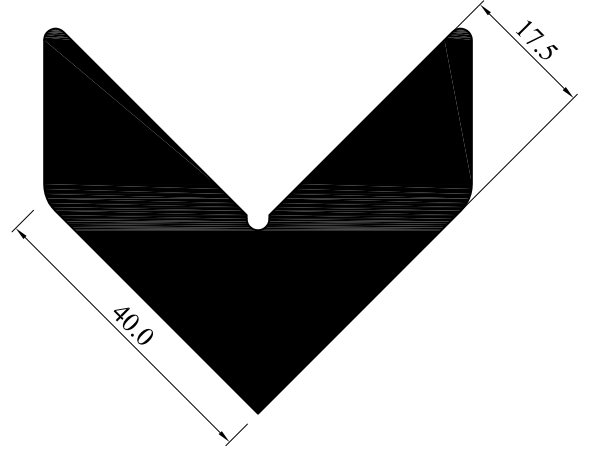

C90-175
Çavuş Gönye

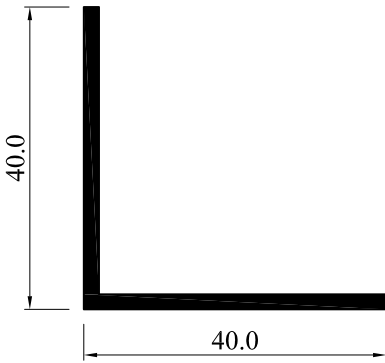

0715-20
Köşebent

0715-20	KESİM ÖLÇÜSÜ	ADET
54051-15	20.0 mm	1
54052-15	20.0 mm	1
54053-15	20.0 mm	2
54054-15	30.0 mm	2

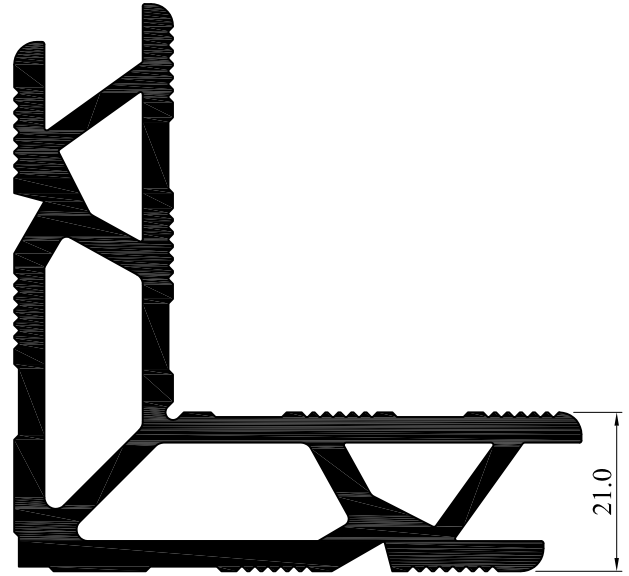

T851-210
Köşe Takoğu (54031-12 de kullanılır)

PROFİL KODU	AĞIRLIK (kg/m)
T851-185	2.512
T851-210	3.308
0715-20	0.421

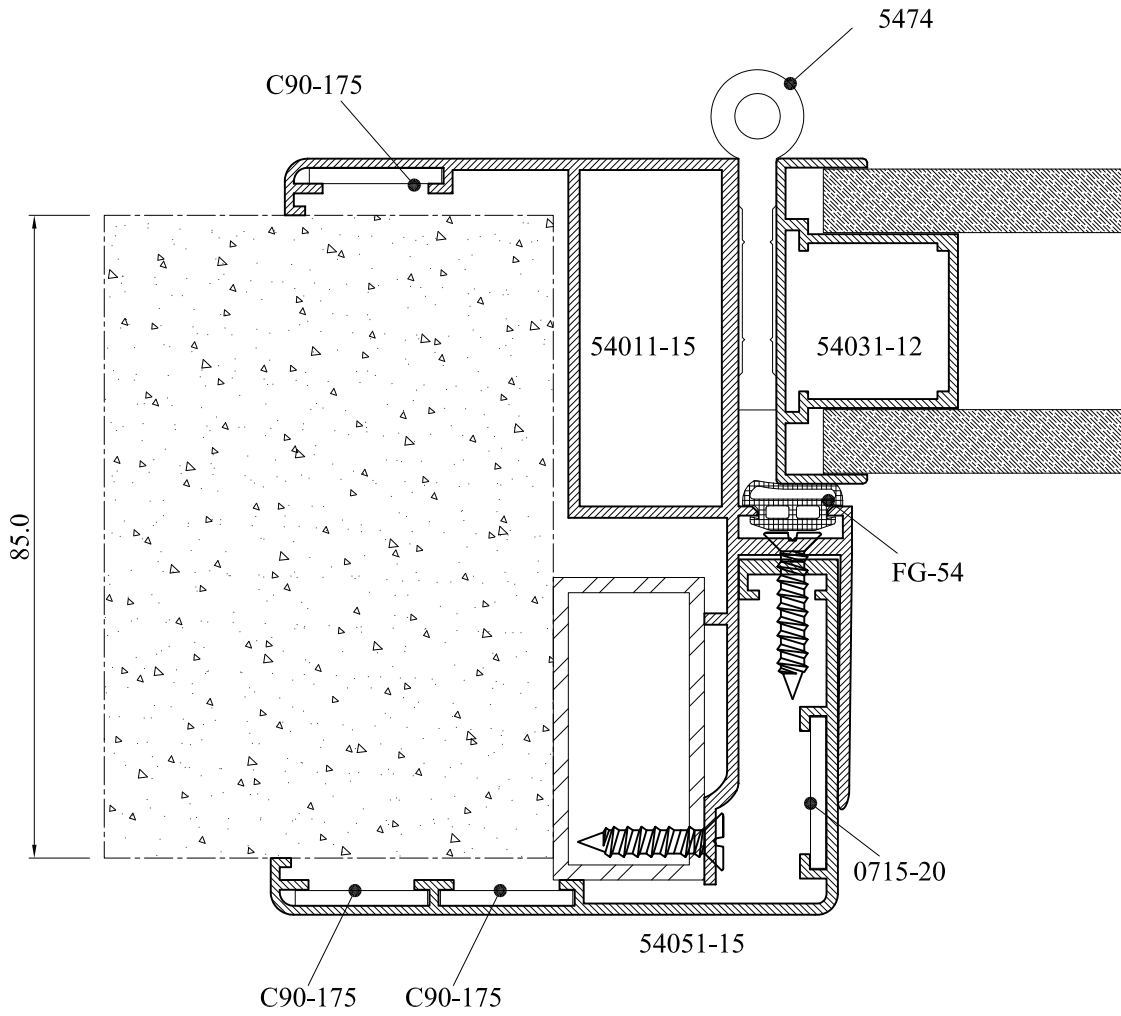
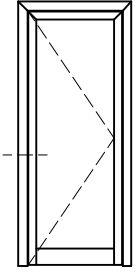

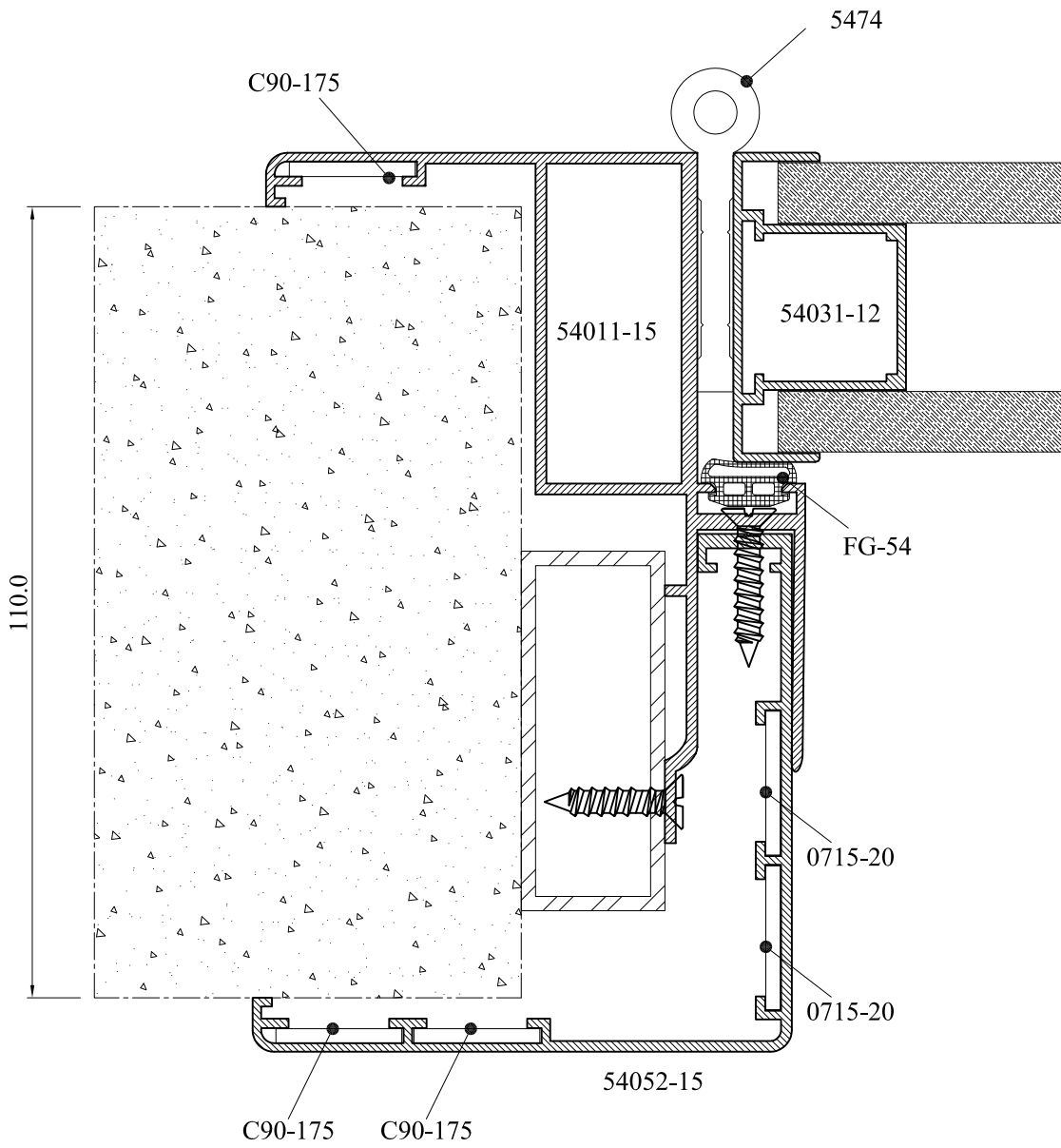
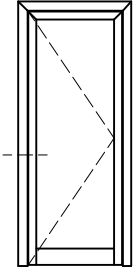

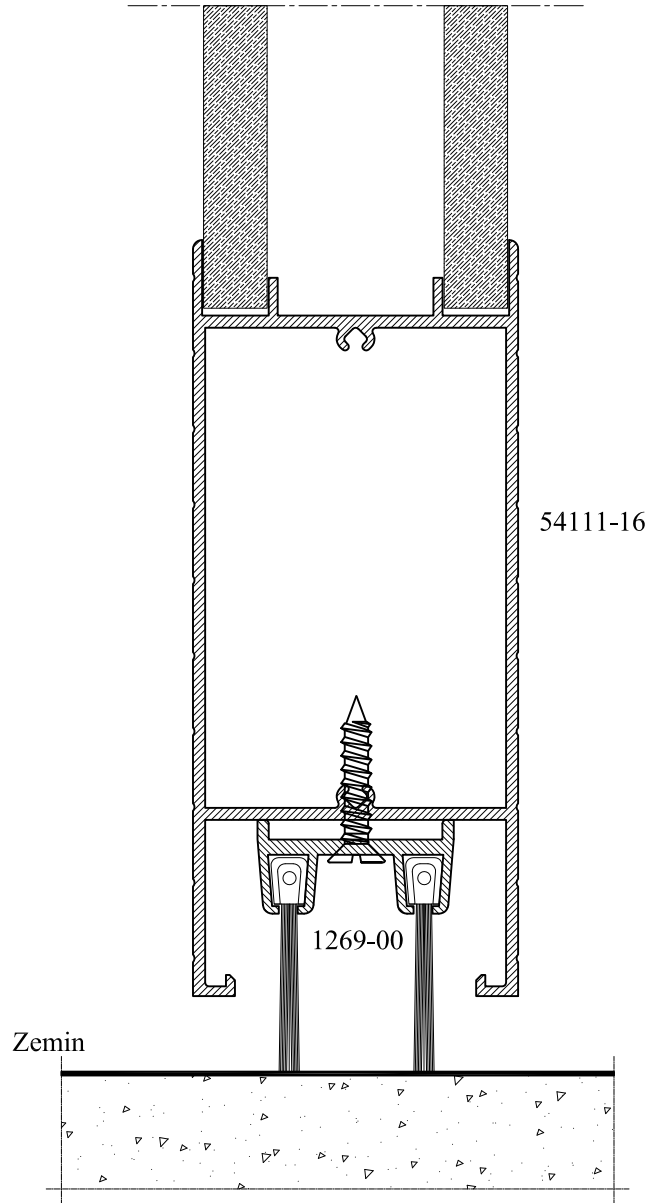
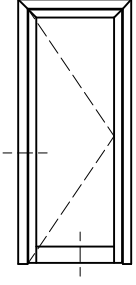

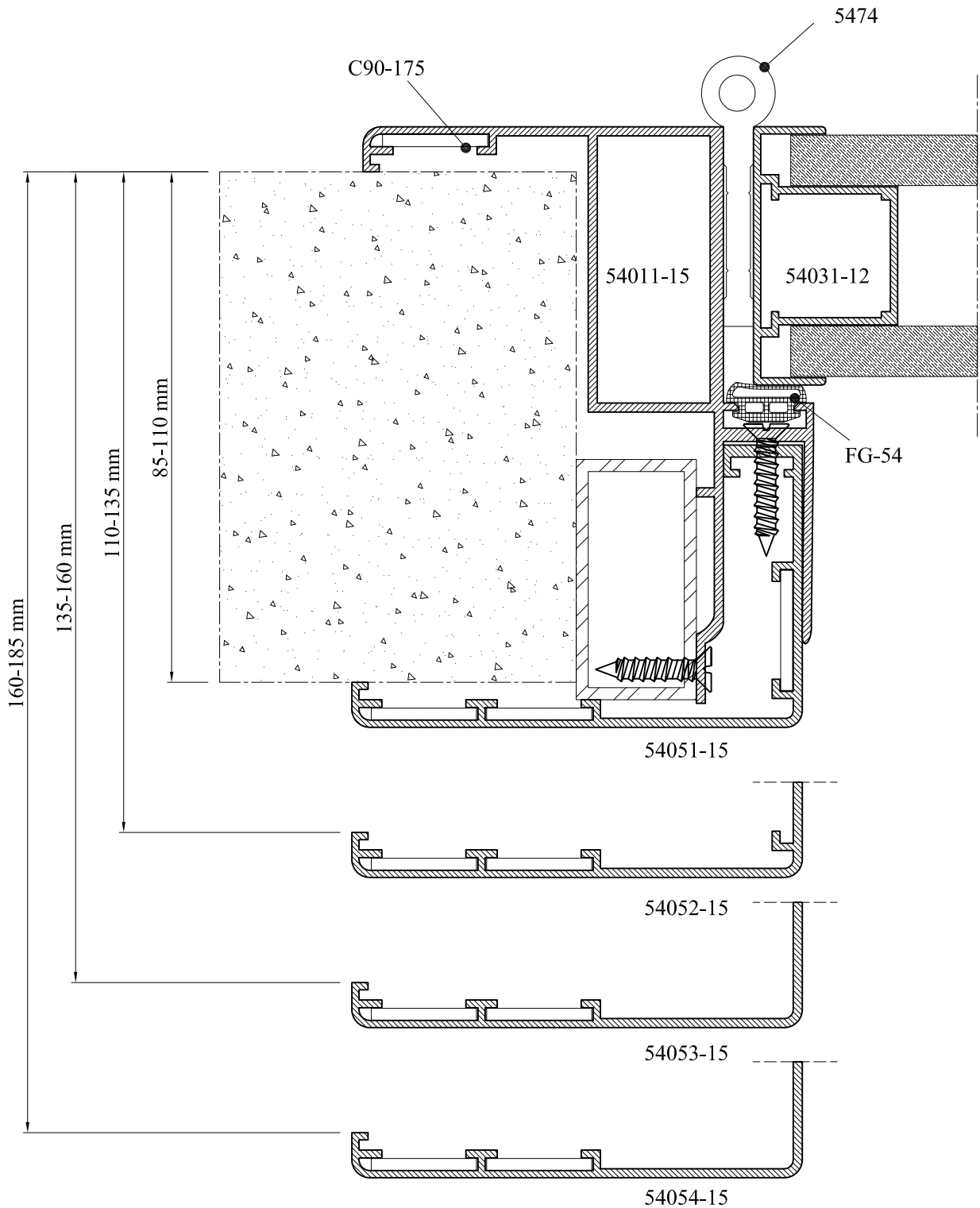
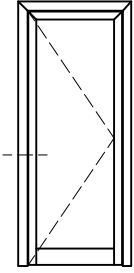

ALTERNATİF (ESKİ) ÇÖZÜMLER

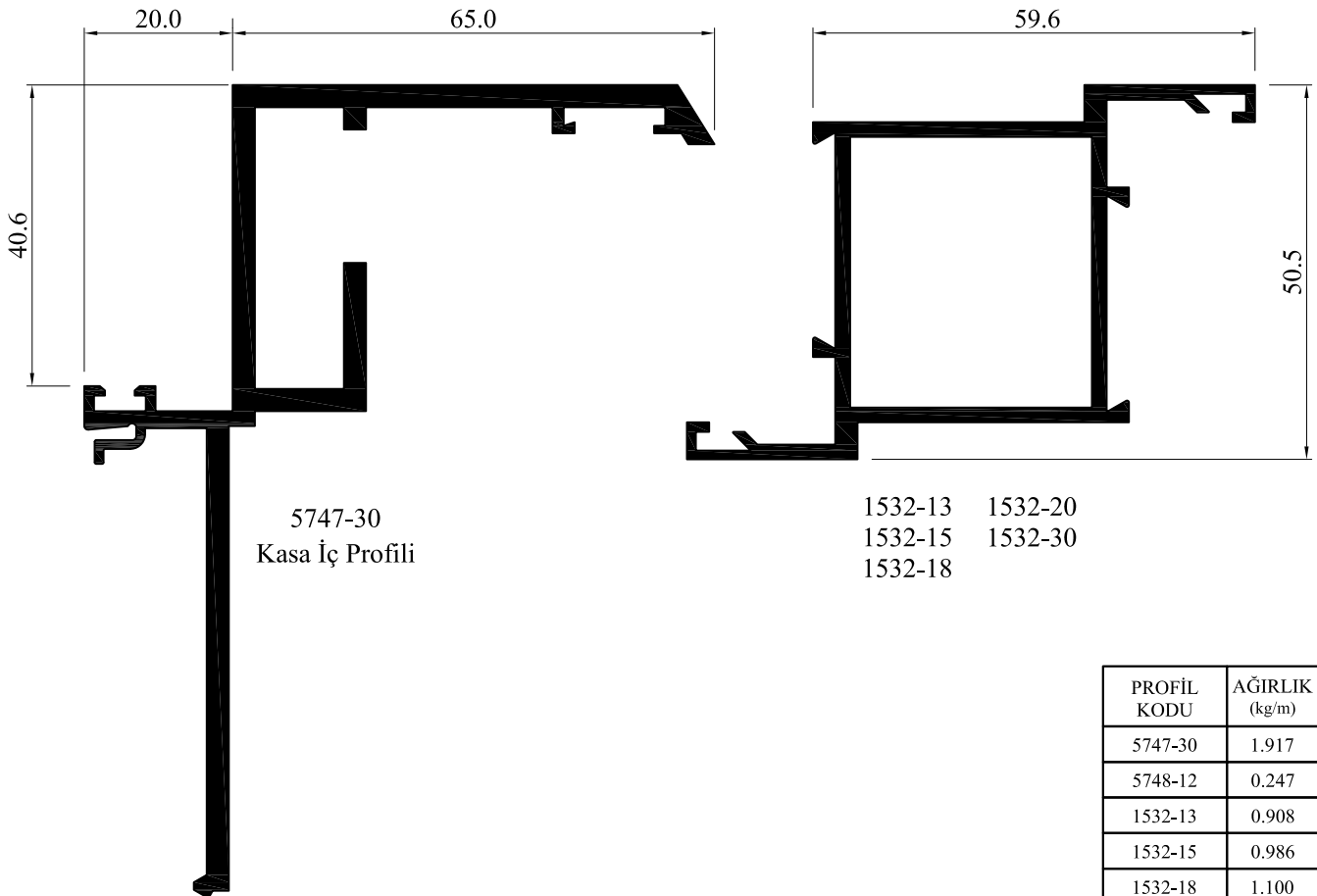

PROFİL KODU	AĞIRLIK (kg/m)
5747-30	1.917
5748-12	0.247
1532-13	0.908
1532-15	0.986
1532-18	1.100
1532-20	1.176
1532-30	1.540

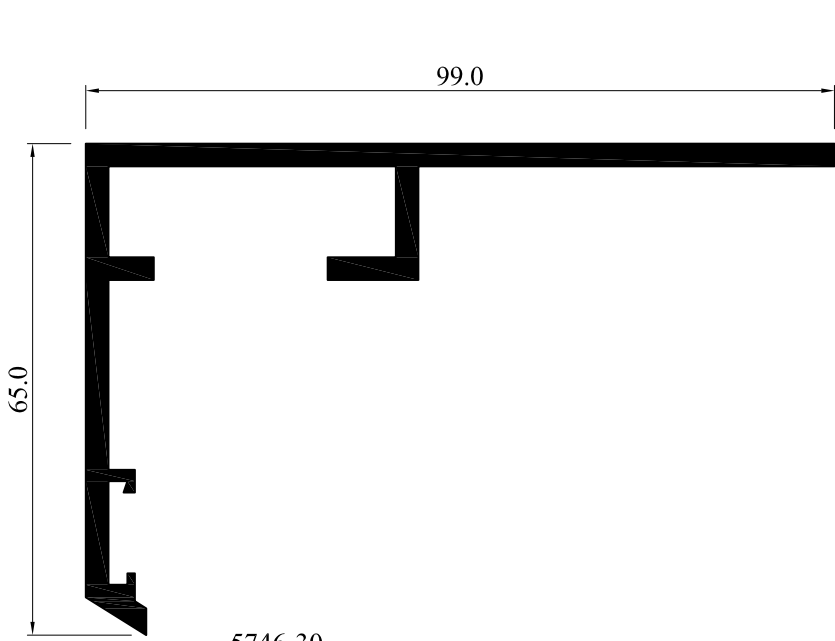

5746-30
Kasa Dış Profili

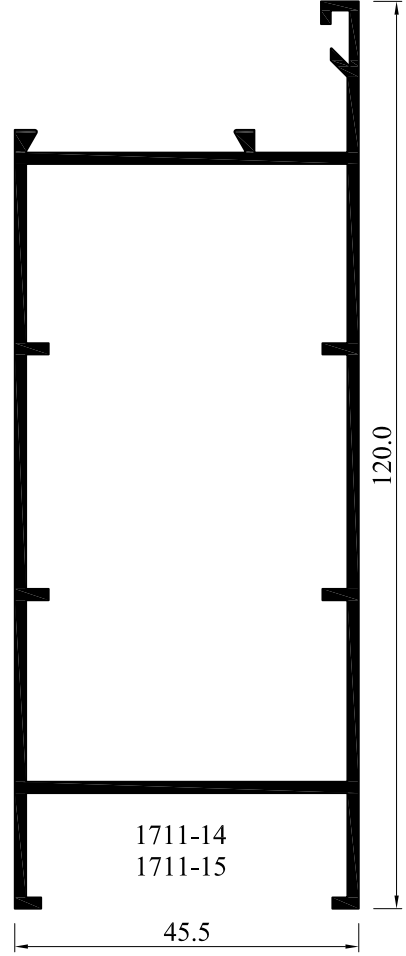

1711-14
1711-15

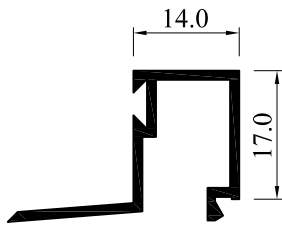

1541-12
1541-20

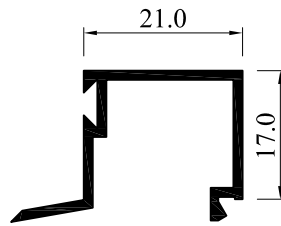

1542-12

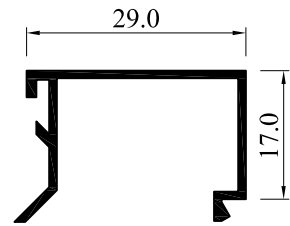

1543-10
1543-12
1543-20

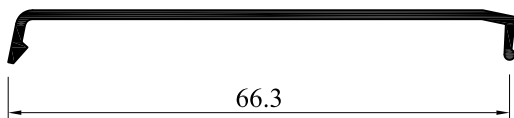

5748-12
Kapatma Çıtası



1571-00

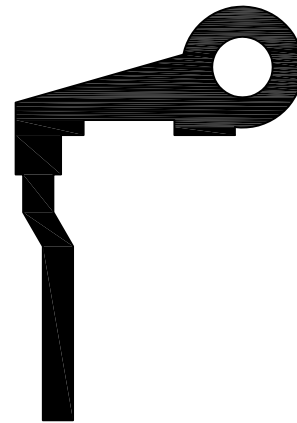

1572-00

PROFİL KODU	AĞIRLIK (kg/m)
1541-12	0.241
1541-20	0.377
1542-12	0.239
1543-10	0.216
1543-12	0.252
1543-20	0.251
5748-12	0.247
1711-14	1.277
1711-15	1.363
5746-30	1.602

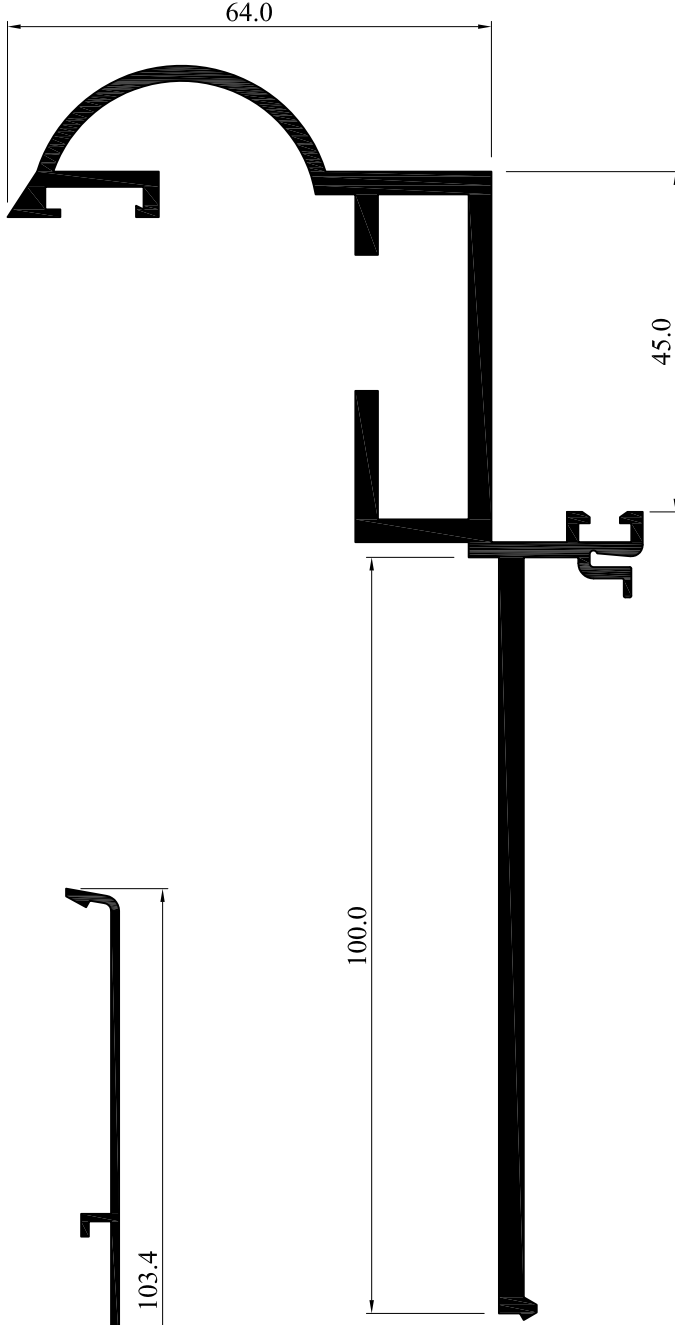

793
Kasa İç Profili

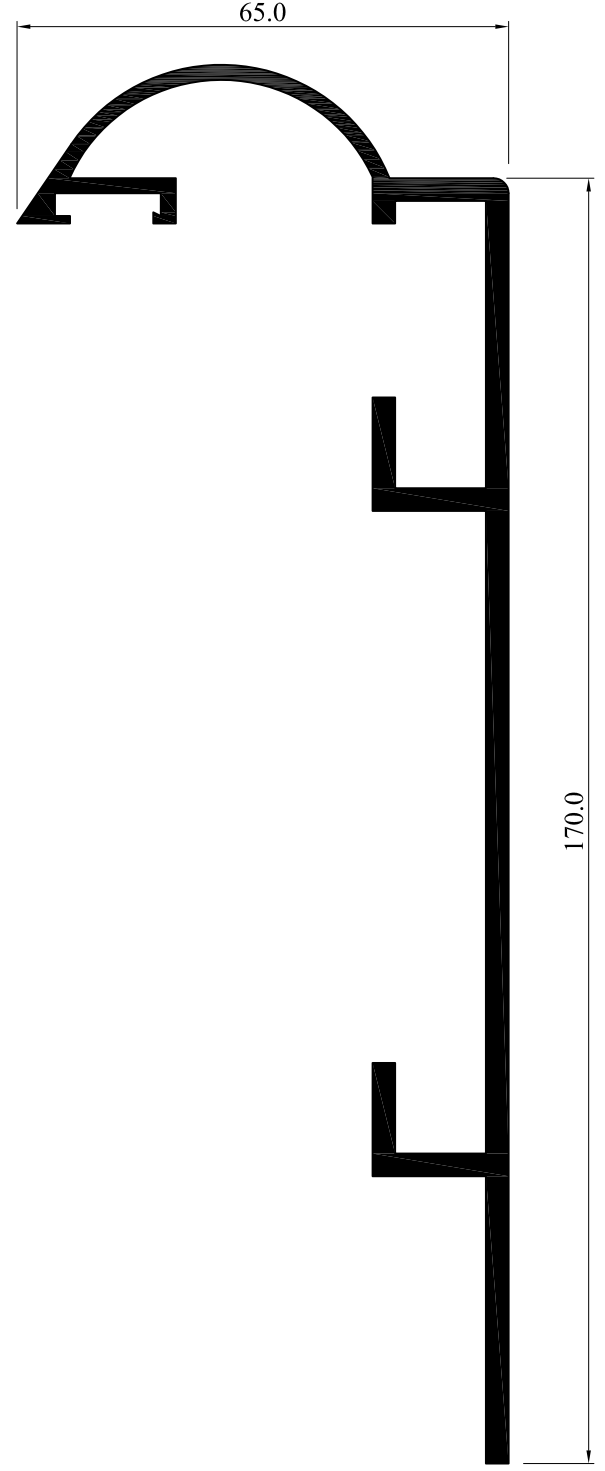

794
Kasa Dış Profili

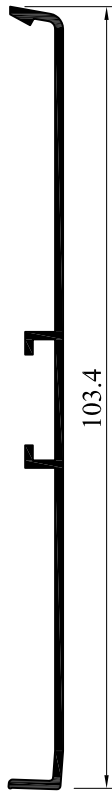

792
Kapatma Çıtası

PROFİL KODU	AĞIRLIK (kg/m)
793	2.403
794	2.425
792	0.360

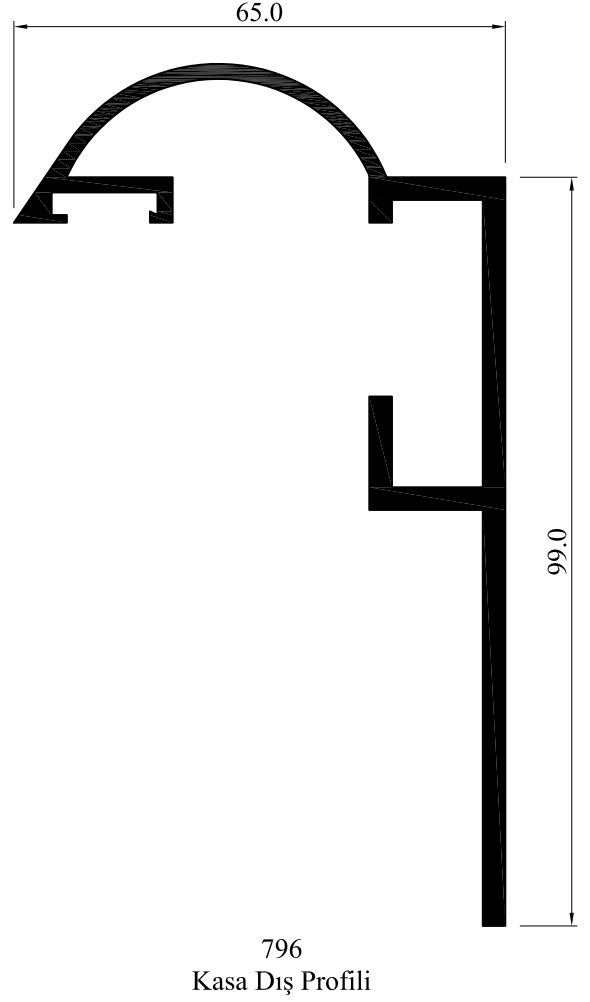
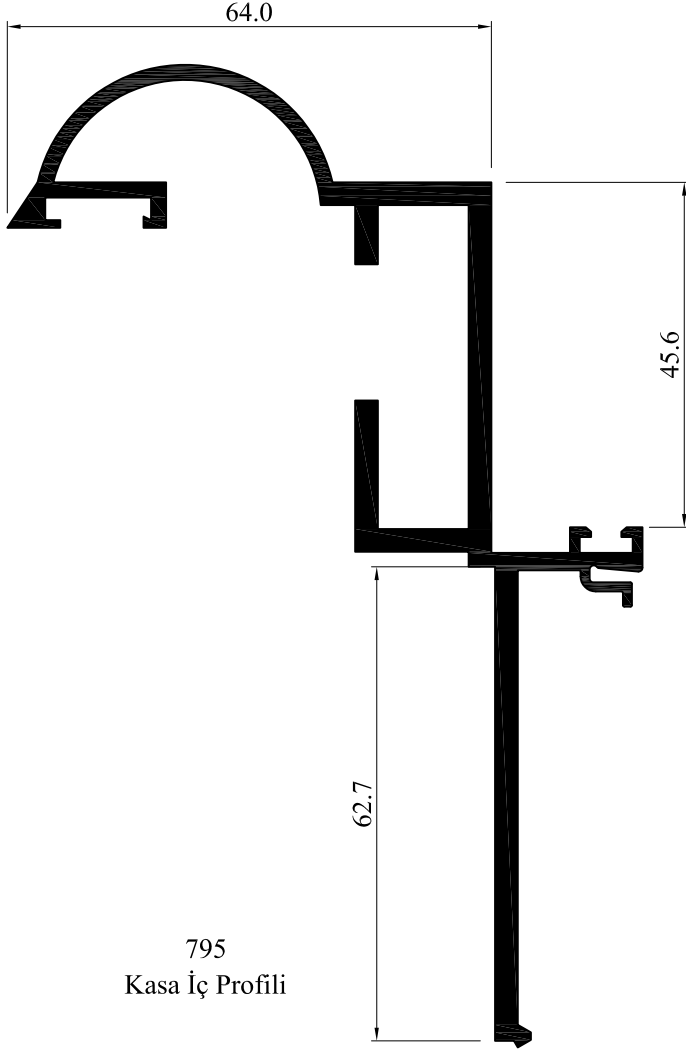

PROFİL KODU	AĞIRLIK (kg/m)
795	2.041
796	1.631

